

OPEN SURGERY

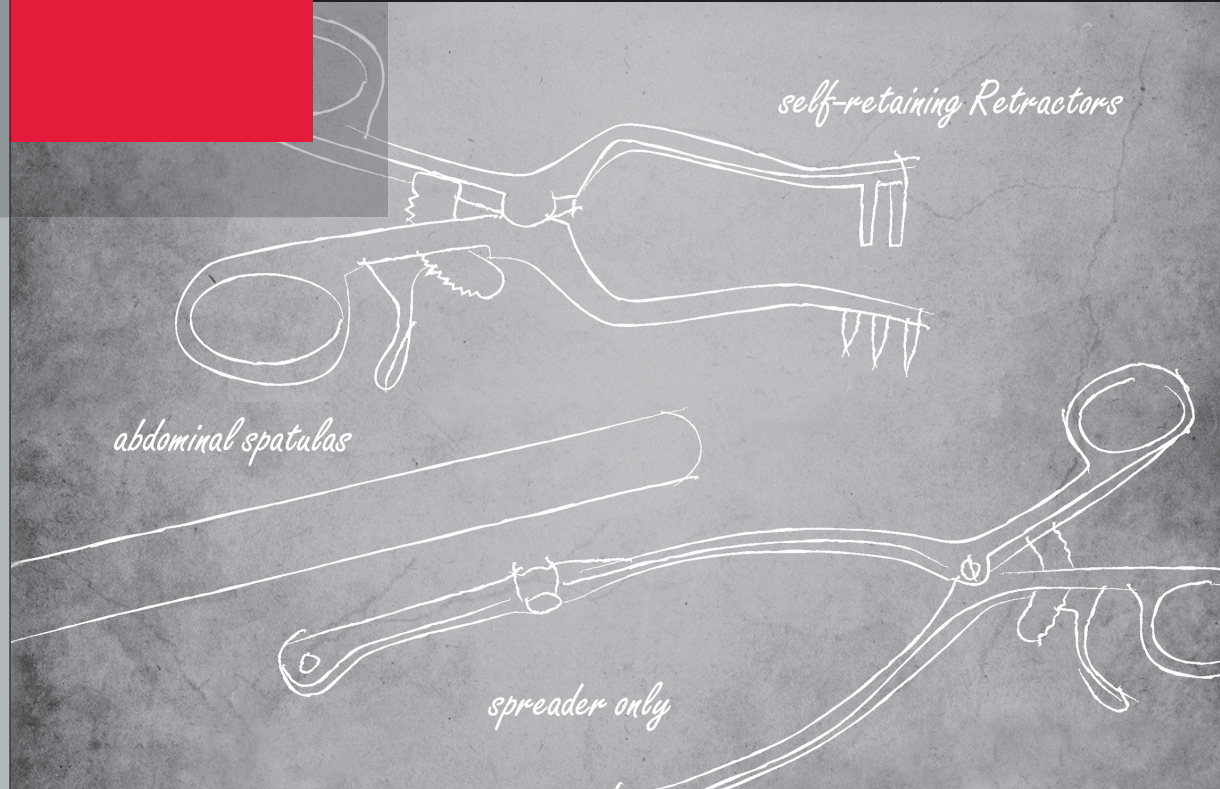

Bauchdeckenhalter
Abdominal Retractors

Separadores abdominales

Ecarteurs abdominaux

Divaricatori autostatici

074-078

Bauchdeckenhalter
Abdominal Retractors

Separadores abdominales

Ecarteurs abdominaux

Divaricatori addominali

Art.Nr. Beschreibung | Description Size Spez.

RICARD

SET



074-310-28

bestehend aus:

- 074-310-10 1 Sperrer
- 074-399-14 1 Paar Seitenvalven 72 x 85 mm
- 074-310-03 1 Mittelvalve 80 x 90 mm

consisting of:

- 074-310-10 1 Spreader
- 074-399-14 1 Pair lateral valves 72 x 85 mm
- 074-310-03 1 Central valve 80 x 90 mm

compuesto de:

- 074-310-10 1 Separador
- 074-399-14 1 Par de valvas laterales 72 x 85 mm
- 074-310-03 1 Valva central 80 x 90 mm

composé de:

- 074-310-10 1 Ecarteur
- 074-399-14 1 Paire de valves latérales 72 x 85 mm
- 074-310-03 1 Valve centrale 80 x 90 mm

composto da:

- 074-310-10 1 Divaricatore
- 074-399-14 1 Paio di valve laterali 72 x 85 mm
- 074-310-03 1 Valva centrale 80 x 90 mm

074-312-30

bestehend aus:

- 074-312-10 1 Sperrer
- 074-399-13 1 Paar Seitenvalven 60 x 80 mm
- 074-310-02 1 Mittelvalve 55 x 70 mm

consisting of:

- 074-312-10 1 Spreader
- 074-399-13 1 Pair lateral valves 60 x 80 mm
- 074-310-02 1 Central valve 55 x 70 mm

compuesto de:

- 074-312-10 1 Separador
- 074-399-13 1 Par de valvas laterales 60 x 80 mm
- 074-310-02 1 Valva central 55 x 70 mm

composé de:

- 074-312-10 1 Ecarteur
- 074-399-13 1 Paire de valves latérales 60 x 80 mm
- 074-310-02 1 Valve centrale 55 x 70 mm

composto da:

- 074-312-10 1 Divaricatore
- 074-399-13 1 Paio di valve laterali 60 x 80 mm
- 074-310-02 1 Valva centrale 55 x 70 mm

Mittelvalven
Central valves

Valvas centrales
Valves centrales
Valve centrali

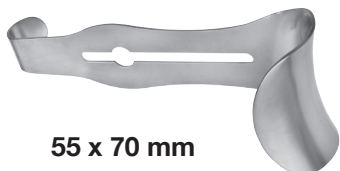

074-310-02 55 x 70 mm

074-310-03 80 x 90 mm

Seitenvalven
Lateral valves

Valvas laterales
Valves latérales
Valve laterali

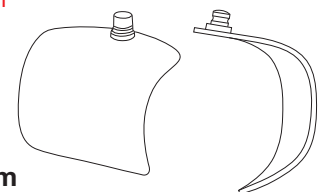

074-399-10 50 x 58 mm

074-399-14 72 x 85 mm

074-399-13 60 x 80 mm

Bauchdeckenhalter
Abdominal Retractors

Separadores abdominales

Ecarteurs abdominaux

Divaricatori addominali

Art.Nr.	Beschreibung Description	Size	Spez.
074-330-18	COLLIN-BABY	18,0 cm; 6 1/8"	SET

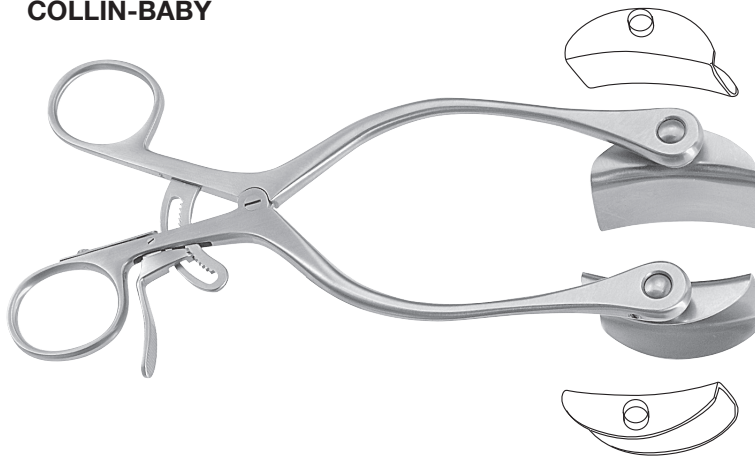

bestehend aus:

- 1 Sperrer
- 074-330-23 1 Paar Seitenvalven 23 x 44 mm
- 074-330-30 1 Paar Seitenvalven 30 x 44 mm

consisting of:

- 1 Spreader
- 074-330-23 1 Pair lateral valves 23 x 44 mm
- 074-330-30 1 Pair lateral valves 30 x 44 mm

compuesto de:

- 1 Separador
- 074-330-23 1 Par de valvas laterales 23 x 40 mm
- 074-330-30 1 Par de valvas laterales 30 x 44 mm

composé de:

- 1 Ecarteur
- 074-330-23 1 Paire de valves latérales 23 x 40 mm
- 074-330-30 1 Paire de valves latérales 30 x 44 mm

composto da:

- 1 Divaricatore
- 074-330-23 1 Paio di valve laterali 23 x 40 mm
- 074-330-30 1 Paio di valve laterali 30 x 44 mm

Seitenvalven
Lateral valves

Valvas laterales

Valves latérales

Valve laterali

074-330-23 23 x 44 mm

074-330-30 30 x 44 mm

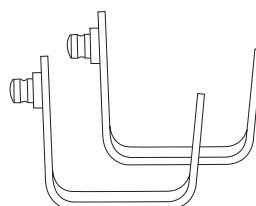

074

Bauchdeckenhalter
Abdominal Retractors

Separadores abdominales

Ecarteurs abdominaux

Divaricatori addominali

TONTARRA

Art.Nr. Beschreibung | Description Size Spez.

COLLIN

23,5 cm; 9 1/4"

SET



074-330-24

bestehend aus:

- 1 Sperrer
- 074-398-10 1 Paar Seitenvalven 32 x 62 mm
- 074-331-01 1 Mittelvalve 55 x 55 mm

consisting of:

- 1 Spreader
- 074-398-10 1 Pair lateral valves 32 x 62 mm
- 074-331-01 1 Central valve 55 x 55 mm

compuesto de:

- 1 Separador
- 074-398-10 1 Par de valvas laterales 32 x 62 mm
- 074-331-01 1 Valva central 55 x 55 mm

composé de:

- 1 Ecarteur
- 074-398-10 1 Paire de valves latérales 32 x 62 mm
- 074-331-01 1 Valve centrale 55 x 55 mm

composto da:

- 1 Divaricatore
- 074-398-10 1 Paio di valve laterali 32 x 62 mm
- 074-331-01 1 Valva centrale 55 x 55 mm

074-332-24

bestehend aus:

- 1 Sperrer
- 074-398-11 1 Paar Seitenvalven 38 x 80 mm
- 074-331-02 1 Mittelvalve 55 x 65 mm

consisting of:

- 1 Spreader
- 074-398-11 1 Pair lateral valves 38 x 80 mm
- 074-331-02 1 Central valve 55 x 65 mm

compuesto de:

- 1 Separador
- 074-398-11 1 Par de valvas laterales 38 x 80 mm
- 074-331-02 1 Valva central 55 x 65 mm

composé de:

- 1 Ecarteur
- 074-398-11 1 Paire de valves latérales 38 x 80 mm
- 074-331-02 1 Valve centrale 55 x 65 mm

composto da:

- 1 Divaricatore
- 074-398-11 1 Paio di valve laterali 38 x 80 mm
- 074-331-02 1 Valva centrale 55 x 65 mm

Mittelvalven
Central valves

Valvas centrales
Valves centrales
Valve centrali

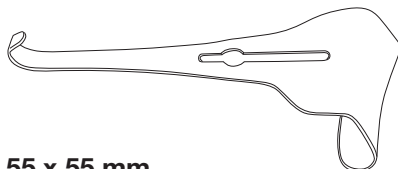

074-331-01 55 x 55 mm

Seitenvalven
Lateral valves

Valvas laterales
Valves latérales
Valve laterali

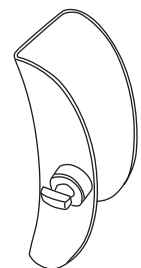

074-398-10 32 x 62 mm

074

Bauchdeckenhalter
Abdominal Retractors

Separadores abdominales

Ecarteurs abdominaux

Divaricatori addominali

Art.Nr.	Beschreibung Description	Size	Spez.
074-334-24	COLLIN	23,5 cm; 9 1/4"	SET



bestehend aus:

- 1 Sperrer
- 1 Paar Seitenvalven 38 x 100 mm
- 1 Mittelvalve 55 x 75 mm

074-398-12
074-331-03

consisting of:

- 1 Spreader
- 1 Pair lateral valves 38 x 100 mm
- 1 Central valve 55 x 75 mm

074-398-12
074-331-03

compuesto de:

- 1 Separador
- 1 Par de valvas laterales 38 x 100 mm
- 1 Valva central 55 x 75 mm

074-398-12
074-331-03

composé de:

- 1 Ecarteur
- 1 Paire de valves latérales 38 x 100 mm
- 1 Valve centrale 55 x 75 mm

074-398-12
074-331-03

composto da:

- 1 Divaricatore
- 1 Paio di valve laterali 38 x 100 mm
- 1 Valva centrale 55 x 75 mm

074-398-12
074-331-03

Mittelvalve
Central valves

Valva central
Valve centrale
Valva centrale

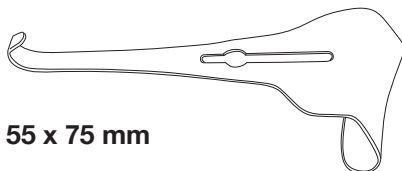

074-331-03

55 x 75 mm

Seitenvalve
Lateral valves

Valvas laterales
Valves latérales
Valve laterali

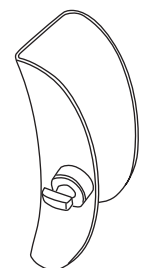

074-398-12

38 x 100 mm

074-398-13

60 x 80 mm

Bauchdeckenhalter
Abdominal Retractors

Separadores abdominales

Ecarteurs abdominaux

Divaricatori addominali

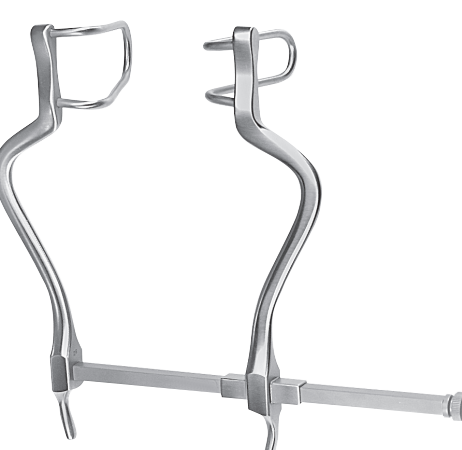
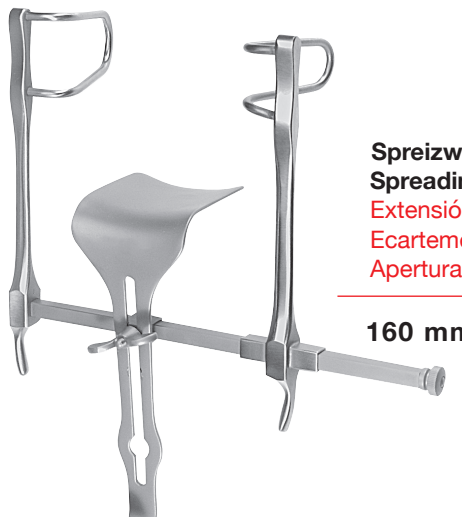
Art.Nr.	Beschreibung Description	Size	Spez.
074-400-10	<p>GOSSET-BABY</p> 	12,5 cm; 4 7/8"	
<p>Spreizweite Spreading Extensión Ecartement Apertura</p>		<p>Seitenvalven Lateral valves Valvas laterales Valves latérales Valve laterali</p>	
100 mm		40 x 30 mm	
074-412-14	<p>GOSSET</p> 	18,5 cm; 7 2/8"	
<p>Spreizweite Spreading Extensión Ecartement Apertura</p>		<p>Seitenvalven Lateral valves Valvas laterales Valves latérales Valve laterali</p>	
140 mm		63 x 35 mm	
074-414-16	<p>GOSSET</p> 	16,5 cm; 6 4/8"	
<p>Spreizweite Spreading Extensión Ecartement Apertura</p>		<p>Seitenvalven Lateral valves Valvas laterales Valves latérales Valve laterali</p>	<p>Mittelvalve Central valve Valva central Valve central Valva centrale</p>
160 mm		63 x 35 mm	60 x 56 mm

074

Bauchdeckenhalter
Abdominal Retractors

Separadores abdominales

Ecarteurs abdominaux

Divaricatori addominali

Art.Nr. Beschreibung | Description Size Spez.

074-460-02 CHARNLEY

SET



bestehend aus:

- 074-462-20 1 Rahmen quadratisch; 8 x 8 mm
- 074-462-02 1 Valve klein; 25 x 38 mm
- 074-462-08 1 Valve groß; 25 x 44 mm
- 074-462-12 1 Gewicht mit Kette

consisting of:

- 074-462-20 1 Frame square; 8 x 8 mm
- 074-462-02 1 Valve small; 25 x 38 mm
- 074-462-08 1 Valve large; 25 x 44 mm
- 074-462-12 1 Weight with chain

compuesto de:

- 074-462-20 1 Cuadro; 8 x 8 mm
- 074-462-02 1 Valva pegueña; 25 x 38 mm
- 074-462-08 1 Valva grande; 25 x 44 mm
- 074-462-12 1 Cadena con peso

composé de:

- 074-462-20 1 Cadre; 8 x 8 mm
- 074-462-02 1 Valve petite; 25 x 38 mm
- 074-462-08 1 Valve grande; 25 x 44 mm
- 074-462-12 1 Chaîne avec poids

composto da:

- 074-462-20 1 Telaio; 8 x 8 mm
- 074-462-02 1 Valva piccola; 25 x 38 mm
- 074-462-08 1 Valva grande; 25 x 44 mm
- 074-462-12 1 Catena con peso

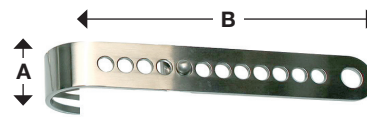
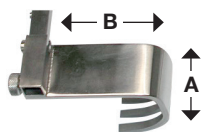

	A	B
074-462-02	25 mm	38 mm
074-462-07	25 mm	75 mm
074-462-14	25 mm	101 mm
074-462-16	25 mm	127 mm
074-462-18	25 mm	25 mm
074-462-21	25 mm	50 mm
074-462-22	25 mm	63 mm
074-462-23	25 mm	57 mm
074-462-27	25 mm	114 mm

	A	B
074-462-08	25 mm	44 mm
074-462-09	25 mm	63 mm
074-462-13	25 mm	75 mm
074-462-15	25 mm	101 mm
074-462-17	25 mm	127 mm
074-462-19	25 mm	25 mm
074-462-24	25 mm	57 mm
074-462-26	25 mm	50 mm
074-462-28	25 mm	114 mm

Bauchdeckenhalter
Abdominal Retractors

Separadores abdominales
Ecarteurs abdominaux
Divaricatori addominali

Art.Nr.	Beschreibung Description	Size	Spez.
074-760-09	BALFOUR-BABY	12,5 cm; 4 7/8"	

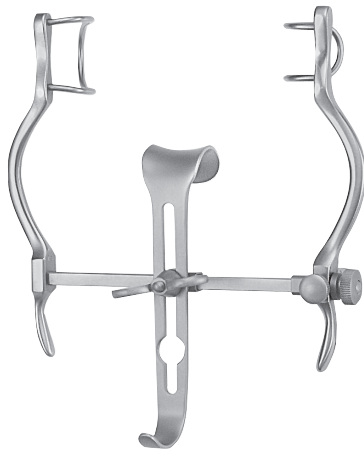

Spreizweite
Spreading
Extensión
Ecartement
Apertura

90 mm

Seitenvalven
Lateral valves
Valvas laterales
Valves latérales
Valve laterali

38 mm

Mittelvalve
Central valve
Valva central
Valve central
Valva centrale

25 x 23 mm

074-764-18	BALFOUR	20,0 cm; 7 7/8"	
------------	---------	-----------------	--

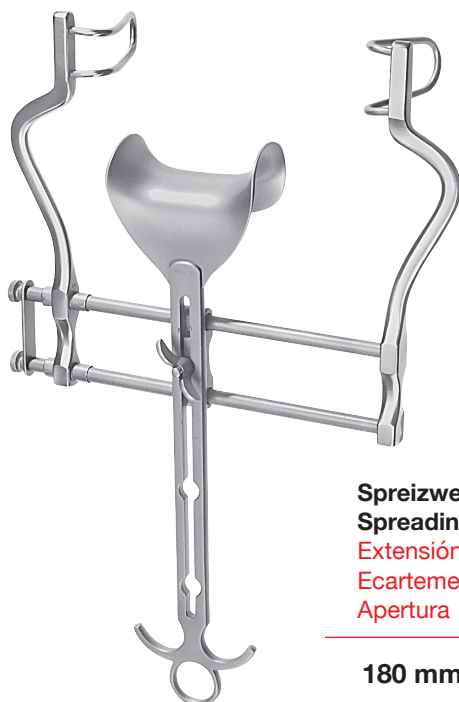

Spreizweite
Spreading
Extensión
Ecartement
Apertura

180 mm

Seitenvalven
Lateral valves
Valvas laterales
Valves latérales
Valve laterali

63 x 35 mm

Mittelvalve
Central valve
Valva central
Valve central
Valva centrale

50 x 75 mm

Bauchdeckenhalter
Abdominal Retractors

Separadores abdominales
Ecarteurs abdominaux
Divaricatori addominali

Art.Nr.	Beschreibung Description	Size	Spez.
074-768-20	BALFOUR	20,0 cm; 7 7/8"	



Spreizweite
Spreading
Extensión
Ecartement
Apertura

200 mm

Seitenvalven
Lateral valves
Valvas laterales
Valves latérales
Valve laterali

100 x 35 mm

Mittelvalve
Central valve
Valva central
Valve central
Valva centrale

100 x 60 mm

074-768-25	BALFOUR	20,0 cm; 7 7/8"	
------------	---------	-----------------	--

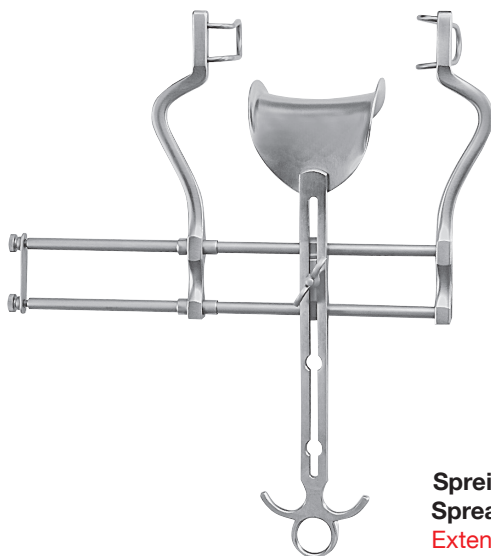

Spreizweite
Spreading
Extensión
Ecartement
Apertura

250 mm

Seitenvalven
Lateral valves
Valvas laterales
Valves latérales
Valve laterali

100 x 35 mm

Mittelvalve
Central valve
Valva central
Valve central
Valva centrale

70 x 85 mm

Bauchdeckenhalter
Abdominal Retractors

Separadores abdominales
Ecarteurs abdominaux
Divaricatori addominali

Art.Nr.	Beschreibung Description	Size	Spez.
074-772-25	BALFOUR US-TYPE	20,0 cm; 7 7/8"	SET

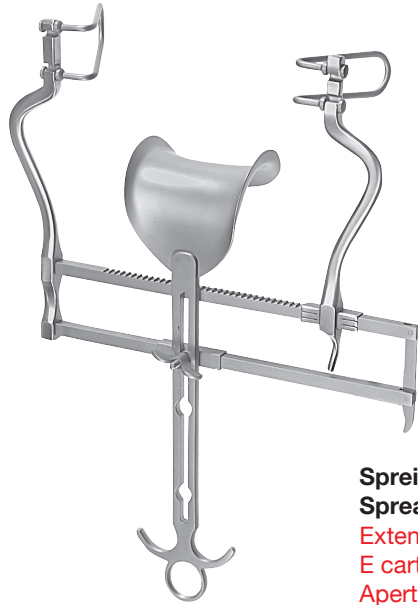

Spreizweite
Spreading
Extensión
E cartement
Apertura

250 mm

Seitenvalven
Lateral valves
Valvas laterales
Valves latérales
Valve laterali

60 x 35 mm
80 x 35 mm

Mittelvalve
Central valve
Valva central
Valve central
Valva centrale

70 x 85 mm

Seitenvalven
Lateral valves
Valvas laterales
Valves latérales
Valve laterali

074-772-01

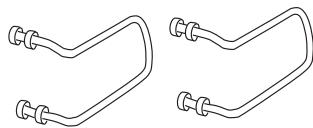

60 x 35 mm

074-772-02

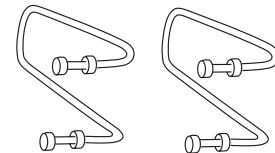

80 x 35 mm

BALFOUR

074-798-01

50 x 75 mm

074-798-02

70 x 85 mm

074-798-03

40 x 68 mm

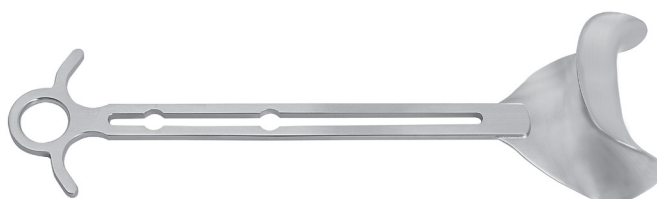

074

Bauchdeckenhalter
Abdominal Retractors

Separadores abdominales

Ecarteurs abdominaux

Divaricatori addominali

Art.Nr. **Beschreibung | Description** **Size** **Spez.**

BALFOUR **Mittelvalven**
Central valves
Valvas centrales
Valves centrales
Valve centrali

074-799-60 100 x 60 mm

074-799-70 100 x 70 mm

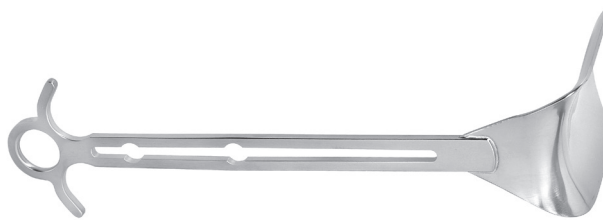

074-870-00 **O`SULLIVAN-O`CONNOR**

SET

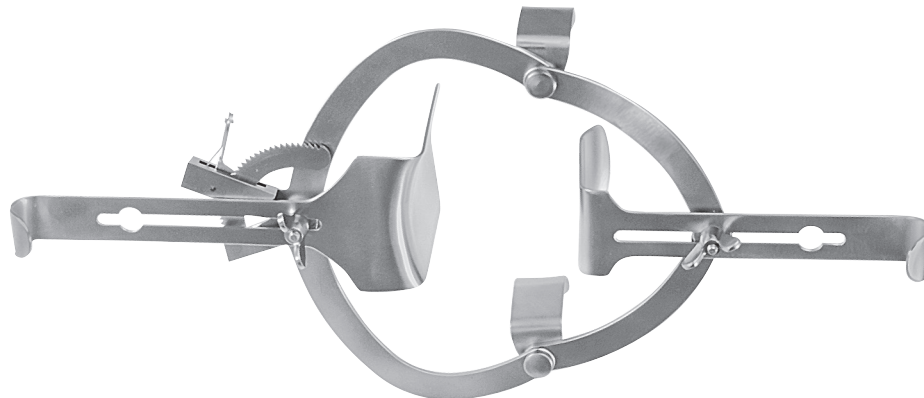

bestehend aus:

- 074-870-01 1 Rahmen mit 2 Seitenvalven 62 x 25 mm
- 074-870-11 2 Valven 80 x 45 mm
- 074-870-12 1 Valve 110 x 70 mm

consisting of:

- 074-870-01 1 Frame with 2 lateral valves 62 x 25 mm
- 074-870-11 2 Valves 80 x 45 mm
- 074-870-12 1 Valve 110 x 70 mm

compuesto de:

- 074-870-01 1 Cuadro con 2 valvas laterales 62 x 25 mm
- 074-870-11 2 Valvas 80 x 45 mm
- 074-870-12 1 Valva 110 x 70 mm

composé de:

- 074-870-01 1 Cadre avec 2 valves latérales 62 x 25 mm
- 074-870-11 2 Valves 80 x 45 mm
- 074-870-12 1 Valve 110 x 70 mm

composto da:

- 074-870-01 1 Telaio con valve laterali 62 x 25 mm
- 074-870-11 2 Valve 80 x 45 mm
- 074-870-12 1 Valva 110 x 70 mm

Bauchdeckenhalter Abdominal Retractors

Separadores abdominales

Ecarteurs abdominaux

Divaricatori addominali

TONTARRA

Art.Nr. Beschreibung | Description Size Spez.

074-880-00 KIRSCHNER

SET

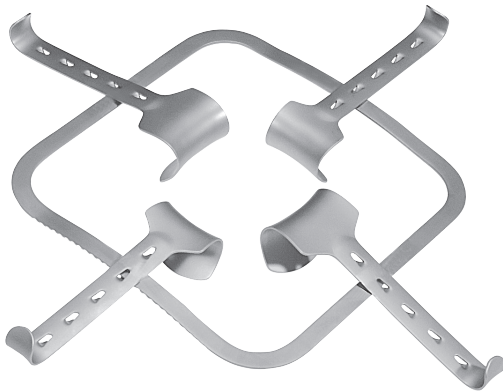

bestehend aus:

- 074-880-01 1 starrer Rahmen 240 x 240 mm
- 074-880-13 2 Valven 40 x 55 mm
- 074-880-14 2 Valven 50 x 65 mm

consisting of:

- 074-880-01 1 fixed frame 240 x 240 mm
- 074-880-13 2 Valves 40 x 55 mm
- 074-880-14 2 Valves 50 x 65 mm

compuesto de:

- 074-880-01 1 Cuadro fijo 240 x 240 mm
- 074-880-13 2 Valvas 40 x 55 mm
- 074-880-14 2 Valvas 50 x 65 mm

composé de:

- 074-880-01 1 Cadre rigide 240 x 240 mm
- 074-880-13 2 Valves 40 x 55 mm
- 074-880-14 2 Valves 50 x 65 mm

composto da:

- 074-880-01 1 Telaio fisso 240 x 240 mm
- 074-880-13 2 Valve 40 x 55 mm
- 074-880-14 2 Valve 50 x 65 mm

074-884-00 KIRSCHNER

SET



bestehend aus:

- 074-884-01 1 starrer Rahmen 300 x 240 mm
- 074-880-14 3 Valven 50 x 65 mm
- 074-880-15 1 Valve 80 x 90 mm
- 074-880-20 1 Valve 98 x 50 mm
- 074-880-21 1 Valve 105 x 35 mm

consisting of:

- 074-884-01 1 fixed frame 300 x 240 mm
- 074-880-14 3 Valves 50 x 65 mm
- 074-880-15 1 Valve 80 x 90 mm
- 074-880-20 1 Valve 98 x 50 mm
- 074-880-21 1 Valve 105 x 35 mm

compuesto de:

- 074-884-01 1 Cuadro fijo 300 x 240 mm
- 074-880-14 3 Valvas 50 x 65 mm
- 074-880-15 1 Valva 80 x 90 mm
- 074-880-20 1 Valva 98 x 50 mm
- 074-880-21 1 Valva 105 x 35 mm

composé de:

- 074-884-01 1 Cadre rigide 300 x 240 mm
- 074-880-14 3 Valves 50 x 65 mm
- 074-880-15 1 Valve 80 x 90 mm
- 074-880-20 1 Valve 98 x 50 mm
- 074-880-21 1 Valve 105 x 35 mm

composto da:

- 074-884-01 1 Telaio fisso 300 x 240 mm
- 074-880-14 3 Valve 50 x 65 mm
- 074-880-15 1 Valva 80 x 90 mm
- 074-880-20 1 Valva 98 x 50 mm
- 074-880-21 1 Valva 105 x 35 mm

074

Valven für Bauchdeckenhalter
Valves for Abdominal Retractors

Valvas para separadores abdominales
 Valves pour écarteurs abdominaux
 Valve per divaricatori addominali

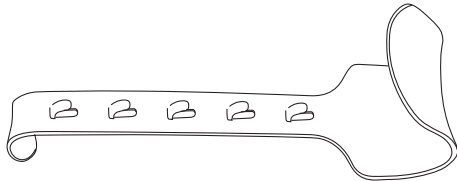
Art.Nr.	Beschreibung Description	Size	Spez.
KIRSCHNER			
074-880-11	60 x 85 mm		
074-880-13	40 x 55 mm		
074-880-14	50 x 65 mm		
074-880-15	80 x 90 mm		
074-880-16	90 x 65 mm		
074-880-17	98 x 95 mm		

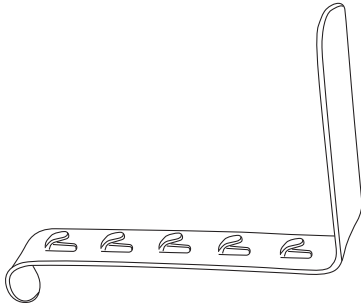
KIRSCHNER			
074-880-20	98 x 50 mm		
074-880-21	105 x 35 mm		

DOYEN			
074-910-11	90 x 50 mm		
074-910-12	105 x 50 mm		
074-910-13	120 x 50 mm		
074-910-14	135 x 50 mm		

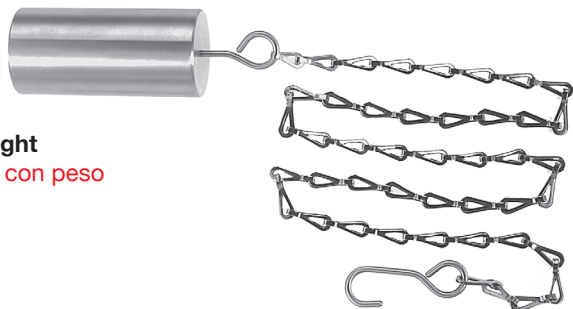
074-915-30	Kette Chain Cadena Chaîne Catena	645 g	
	mit Gewicht with weight con peso avec poid con peso		

074

Bauchdeckenhalter
Abdominal Retractors

Separadores abdominales

Ecarteurs abdominaux

Divaricatori addominali

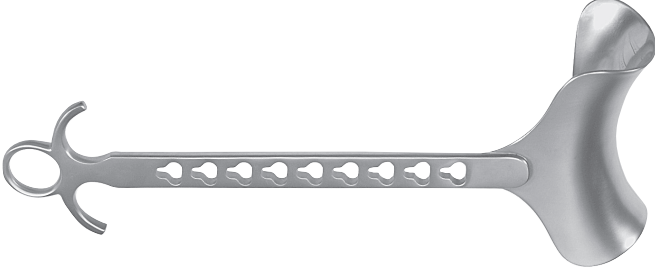
Art.Nr.	Beschreibung <i>Description</i>	Size	Spez.
ROCHARD			
074-920-10	95 x 50 mm		
074-920-11	105 x 50 mm		
074-920-12	120 x 60 mm		
074-920-13	135 x 60 mm		
074-920-16	155 x 60 mm		

074-920-20	Fixiervorrichtung Fixation device Dispositivo de fijación Compas articulé Dispositivo di fissaggio (compasso)	19,5 cm; 7 3/4"
------------	---	-----------------



074

Bauchdeckenhalter
Abdominal Retractors

Separadores abdominales

Ecarteurs abdominaux

Divaricatori addominali

Art.Nr.	Beschreibung Description	Size	Spez.
	<p>Befestigungsgestell zur Fixierung an den Seitenschienen 25 x 10 mm der OP-Tische, zur Sterilisation zerlegbar</p> <p>Mounting frame for fastening to the lateral bars 25 x 10 mm of the operating tables, can be dismantled for sterilization</p> <p>Bastidor para la fijación a las barras laterales 25 x 10 mm de las mesas de operación, desmontable para la esterilización</p> <p>Cadre pour fixation aux barres latérales 25 x 10 mm de la table d'opération, demontable pour la stérilisation</p> <p>Telaio di supporto per il fissaggio alla barra laterale 25 x 10 mm del tavolo operatorio, può essere smontabile per la sterilizzazione</p>		

074-920-01

ROCHARD

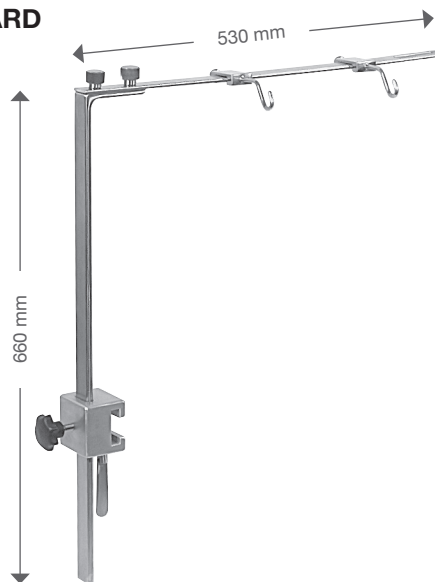

074-920-02

ROCHARD

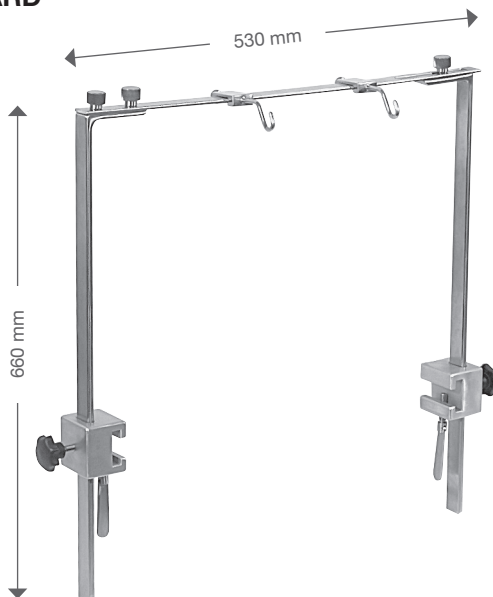

Bauchspatel
Abdominal Spatulas

Espátulas abdominales

Spatules abdominaux

Spatole addominali

Art.Nr.	Beschreibung <i>Description</i>	Size	Spez.
RIBBON			
biegsam malleable maleable malléable malleabile			
078-170-13	330 x 13 mm		
078-170-25	330 x 25 mm		
078-170-32	330 x 32 mm		
078-170-40	330 x 40 mm		
078-170-50	330 x 50 mm		
HABERER			
biegsam malleable maleable malléable malleabile			
078-200-01	280 x 25/30 mm		
078-200-02	300 x 37/45 mm		
078-200-03	300 x 40/50 mm		
RIBBON			
biegsam malleable maleable malléable malleabile			
078-210-06	200 x 6 mm		
078-210-12	200 x 12 mm		
078-210-17	200 x 17 mm		
078-210-20	200 x 20 mm		
078-210-25	250 x 25 mm		
TUFFIER			
biegsam malleable maleable malléable malleabile			
078-220-20	200 x 17/25 mm		

078